



VEOS

TECHNICAL INFORMATION

- A quick and easy-to-install blind system for tilt and turn windows and doors with no screwing or drilling into woodwork required, which allows you to open the window or door with the blind down.

System benefits

Solution for tilt and turn windows and doors

Veos is the new guided roller blind system that is easily attached to a window or door (bottom-hung, side-hung, or tilt and turn) using a hanger-type bracket.

With this Bandalux innovation, the window or door can open with the blind lowered.



Bottom-hung



Side-hung



Tilt and turn

Easy installation

Veos is designed for quick, easy installation:



Follow the simple tutorial steps on how to install VEOS.



Guided system to prevent swaying

The 1.5 mm \varnothing cable guide* on both sides of the blind is a fastening mechanism that keeps the fabric aligned with the door or window. The bottom rail is also secured, preventing sway.

i *Veos can be configured without a guide, though Bandalux recommends using the guide for better fabric support.



Perfect frame fit

The bracket's adjustment screw ensures Veos securely fits frame thickness (max. 25 mm).



Concealed end

The built-in Teadrop bottom rail enhances the blind's aesthetic.



Available colours

The new Bandalux-developed Veos system comes in three colours: White/Black/Grey.



White



Grey



Black



A range of chain options

Choose between a traditional coloured plastic chain or transparent chain.

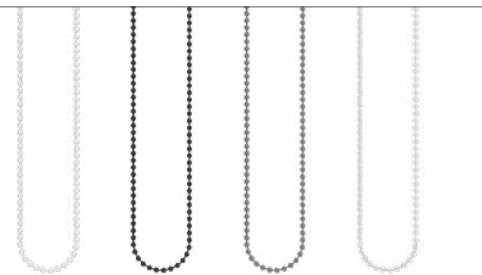

White

Black

Grey

Transparent

Child safety

Bandalux prioritizes security and therefore supplies by default a child safety system that holds the cord or chain tight to the wall to prevent children from getting entangled in it.



Customised digital printing

You can customise the design of your curtain with the image of your choice. Print your own image or choose the one you like best from the wide selection offered by Bandalux.



System benefits



Enormous variety of fabrics and colours

This new system offers a wide range of fabrics: decorative, blackout and Polyscreen®. You can choose from more than 300 options in a range of textures, colours and degrees of transparency.

Also available with Airpure® technology, which purifies the air in any space.



BASE PRICE LIST (INCLUDED IN THE PRICE)

<p>CHAIN-OPERATED</p> 	<p>TEADROP BOTTOM BAR</p> 	<p>VEOS SAFETY CLIP</p> 	<p>SIDE GUIDE ø 1.5 mm</p> 	<p>COMPONENTS COLORS:</p> <ul style="list-style-type: none"> <input type="checkbox"/> White <input type="checkbox"/> Grey <input type="checkbox"/> Black <p> The components color will be paired with the chosen fabric according to Bandalux criteria.</p>
---	---	---	---	---

OTHER OPTIONS

<p>NO CABLE GUIDE</p> 	<p>PERSONALIZATION</p> 
---	--

COLLECTION AIRPURE®

BANDALUX



airPURE®
BLINDS & SHADES

AIRPURE® SHADES:

- Collection Polyscreen® 550 Airpure® in the following colors: Ash, Pearl, White, White Linen and White Pearl.

MINIMUM AND MAXIMUM SIZES

Operating system	Shade width		Shade height		Surface	
	Minimum	Maximum	Minimum	Maximum	Minimum	Maximum
CHAIN	400 mm	1500 mm	200 mm	2000 mm	0,08 m ²	3 m ²

SPACE BETWEEN BRACKET AND FABRIC (GAP) + CONTROL HEIGHTS

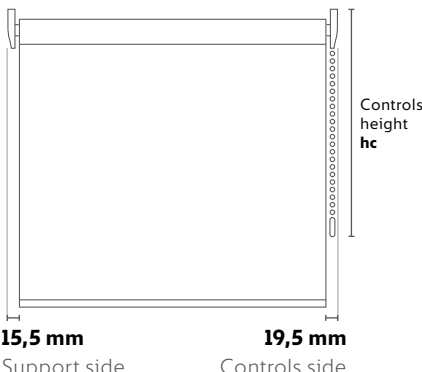

15,5 mm
Support side

19,5 mm
Controls side

CHAIN-OPERATED WITH CHILD SAFETY SYSTEM
The device must be positioned at minimum 1,5m from the floor.

Controls height (mm) hc
540
790
1040
1540
1790
2040

 The controls height will always be measured from the top part of the shade (top of the bracket) to the bottom of the chain tensorer.

BRACKET SIZES AND RETRACTION HEIGHTS (mm)

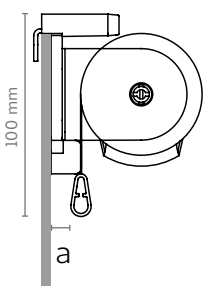

HIDDEN BOTTOM BARS

Min	Max
a = 9	a = 23

Available only by normal rolling direction.

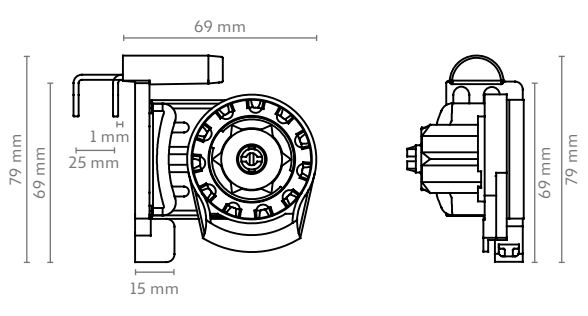

PRODUCTION TOLERANCE

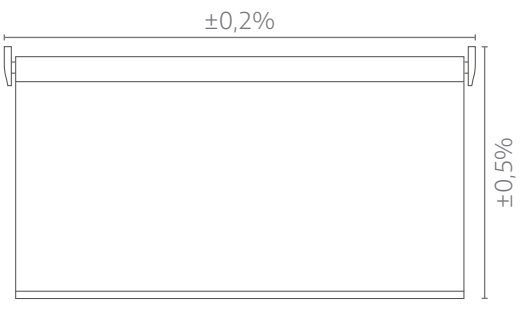

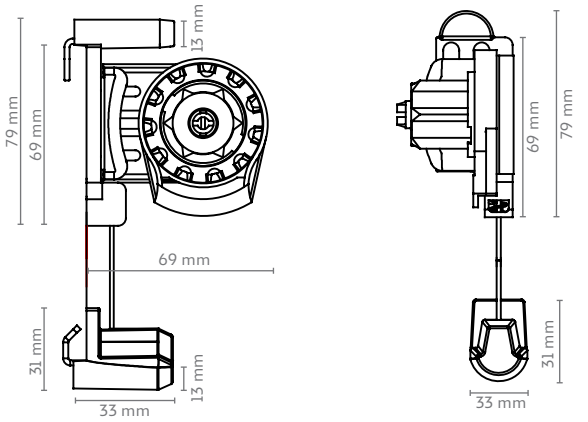

Accordig to EN13120 European standard.

BRACKET SIZES WITH SIDE GUIDES

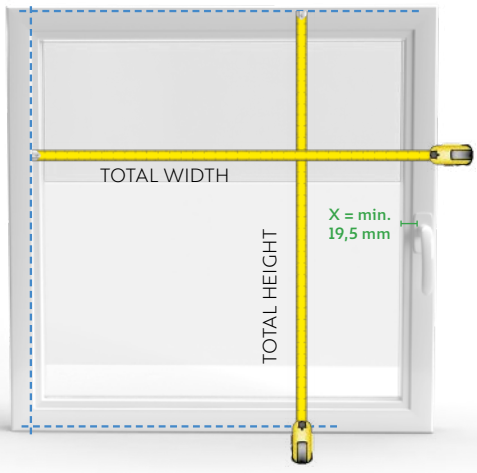

TAKING MEASUREMENTS THE RIGHT WAY





The customer has to provide the blind's width and height, taking into account the following additional measurements of the glass:

- X*: Distance between glass and handle.
- Curtain width with cable guide = Glass width + 2X.
- Curtain width without cable guide = Glass width + 2X + 35 mm.
- Curtain height: Total height of door or window, including frames.
- Minimum distance of 15 mm between the window sash and the floor, and 15 mm between the window sash and the ceiling.

*At least 19.5 mm, otherwise it will not cover the glass.

BANDALUX